



CUBE SERIES

CUBE SERIES | 40.20

Affordable, quality hand crafted sinks.

1 & 1/2 BOWLS



CUBE SERIES 40.20

The CUBE SERIES of sinks offers hand crafted quality at affordable prices. With a wide selection of popular sizes in both single and double bowls, these sinks are made from high grade 18/10, 304, 1mm brushed satin stainless steel.

All the CUBE SERIES sinks are suitable for both top mounting and under mounting, and all sinks feature easy-to-clean 15mm radius corners.

SPECIFICATIONS

Dimensions

Overall Size: 690 x 450 X 200mm
Main Bowl Size: 400 X 400 x 200mm
Small Bowl Size: 200 X 400 x 200mm
Bowl Radius: 15mm
Minimum Cabinet: 750mm

Product Details

Installation: Undermount, Topmount or Welded
Material: High grade, 304, 18/10 Stainless Steel
Thickness: 1mm
Finish: Satin Brushed
Reversible: Yes
Edge detail: Laser Flat

PRODUCT FEATURES

- Sound proofing pads on all sides.
- Special spray on insulation coat which retains water temperature for longer.

Waste & Overflow System

- 2 x Basket wastes included one with overflow kit.
- 90mm waste hole.

Warranty

Lifetime limited warranty on stainless steel.

Product Sku Code

Cube 40.20



MM BRANDS
263 Ti Rakau Drive, East Tamaki,
Auckland 2140, New Zealand.

Help & Support
For more information please go
to our website or contact us.

Call: +64 9 274 0111 or 0800 536 252
Email: sales@mmbrands.co.nz
www.sinxbytotara.co.nz

CUBE SERIES | 40.20

DIMENSIONS

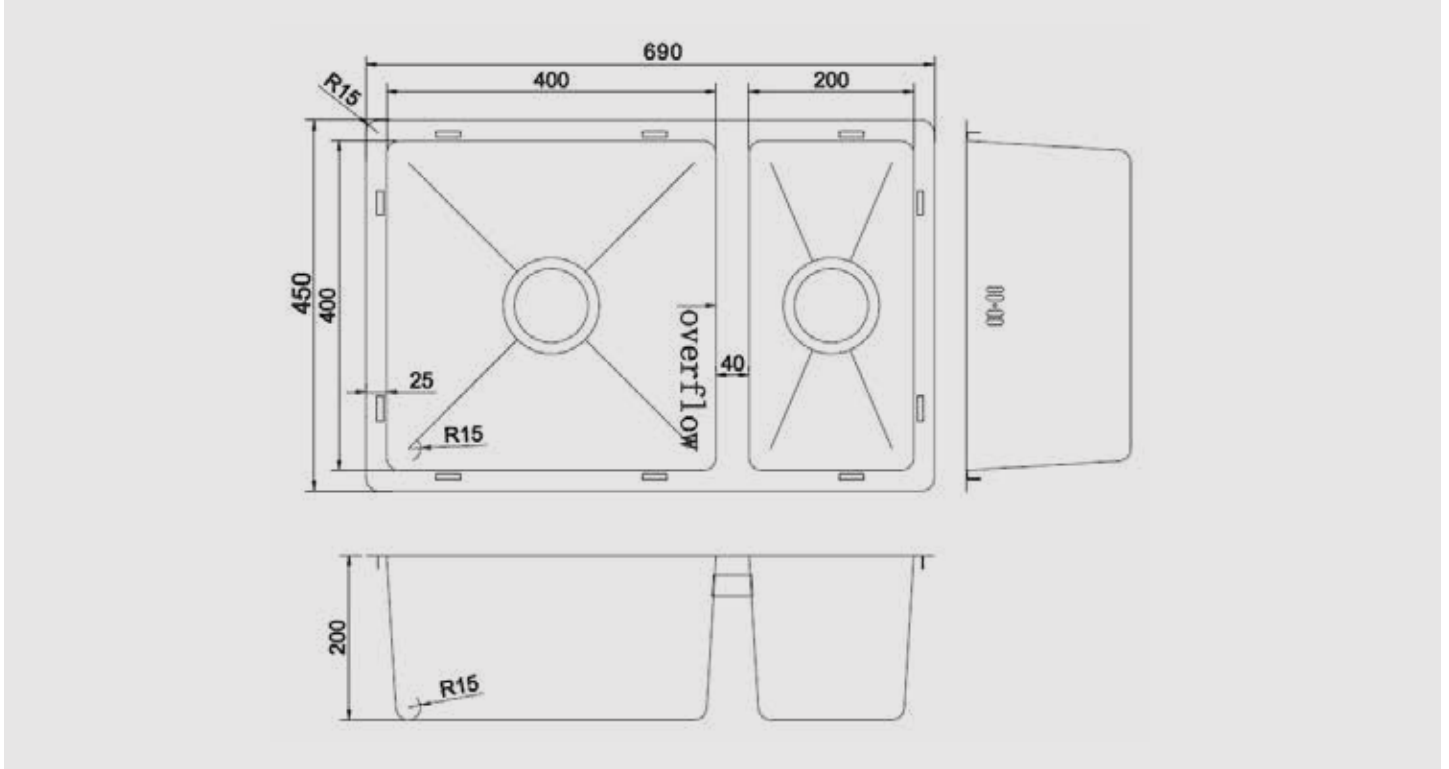

CUT-OUTS FOR BOTH TOPMOUNT & UNDERMOUNT

