

CUBE SERIES | 40

Affordable, quality hand crafted sinks.

1 BOWL

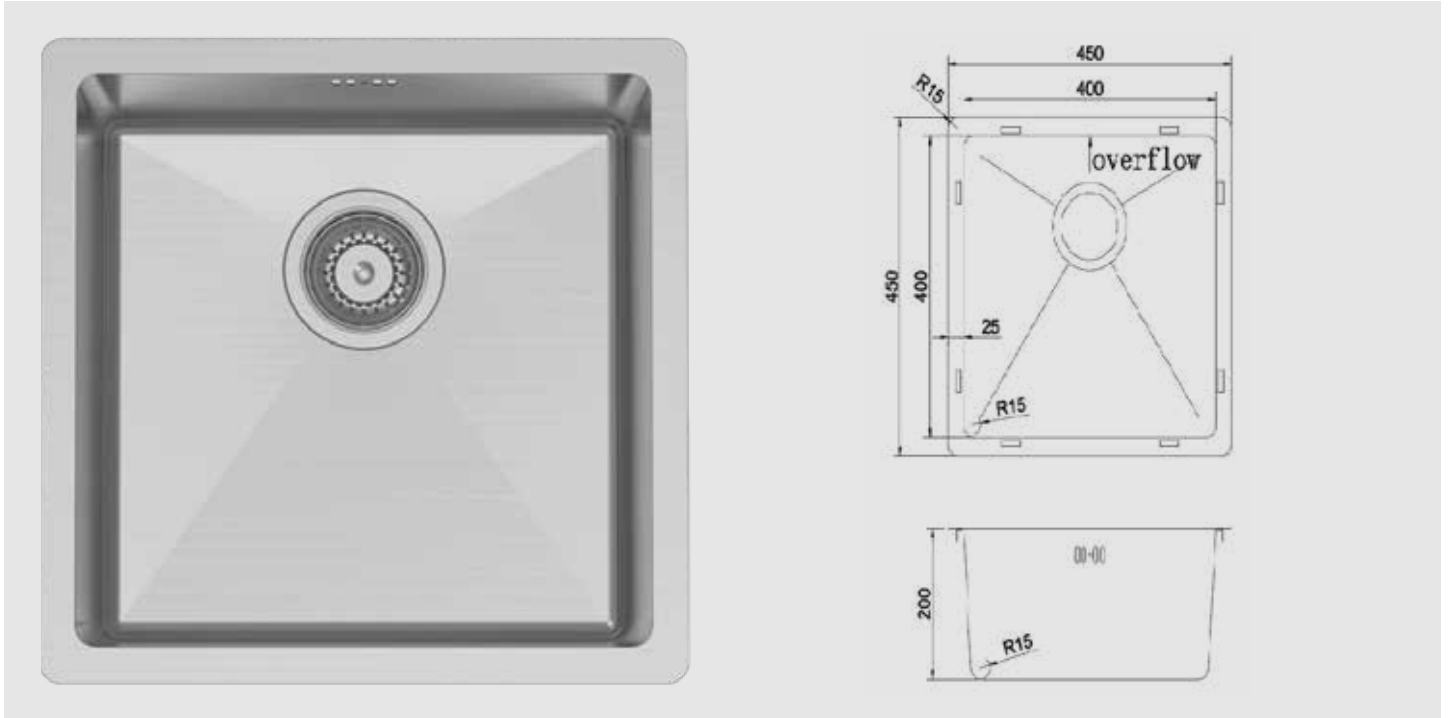

CUBE SERIES 40

The CUBE SERIES of sinks offers hand crafted quality at affordable prices. With a wide selection of popular sizes in both single and double bowls, these sinks are made from high grade 18/10, 304, 1mm brushed satin stainless steel.

All the CUBE SERIES sinks are suitable for both top mounting and under mounting, and all sinks feature easy-to-clean 15mm radius corners.

SPECIFICATIONS

Dimensions

Overall Size: 450 x 450 x 200mm
 Main Bowl Size: 400 X 400 X 200mm
 Bowl Radius: 15mm
 Minimum Cabinet: 500mm

Product Details

Installation: Undermount, Topmount or Welded
 Material: High grade, 304, 18/10 Stainless Steel
 Thickness: 1mm
 Finish: Satin Brushed
 Reversible: No
 Edge detail: Laser Flat

PRODUCT FEATURES

- Sound proofing pads on all sides.
- Special spray on insulation coat which retains water temperature for longer.

Waste & Overflow System

- Basket waste with overflow kit.
- 90mm waste hole.

Warranty

Lifetime limited warranty on stainless steel.

Product Sku Code

Cube 40



CUBE SERIES | 40

CUT-OUTS FOR BOTH TOPMOUNT & UNDERMOUNT

